

Project: \_\_\_\_\_

Fixture Type: \_\_\_\_\_ Quantity: \_\_\_\_\_

Customer: \_\_\_\_\_



**Illuminating**  
ENGINEERING SOCIETY

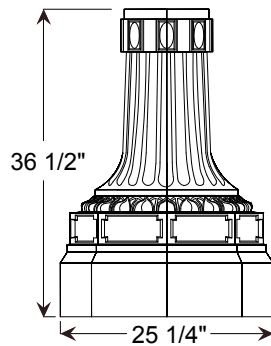

### Specifications

**Material:**

All parts are durable 356 cast aluminum. All hardware provided shall be stainless steel or zinc plated steel.

Available with aluminum bolt down fluted or smooth; direct burial fluted or smooth; or round steel poles. For tapered poles consult factory.

Fits pole diameters: 5"

**Finish:**

A polyester powder coat high quality finish is electro-statically applied and baked at 430° for exceptional durability and color retention. Products undergo an intensive five-step cleansing and pretreatment process for maximum paint adhesion.

Marine grade finish provides superior salt, humidity and UV protection. This coating withstands up to 3000 hours of continuous salt spray, comes with a 5-year warranty and is available in either a textured or gloss surface.

**Modifications:**

Consult factory for custom or modified cast clam shell.

**CCS5509**

Weight: 93 lbs

Catalog Logic

**CCS5509** - **BD5S16.125** - **GFI20** - **72**  
Cast Clam Shell Pole Accessory Finish

Catalog Number

1

2













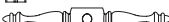

3

**CCS5509** — — —

### 1 POLES

SELECT POLE PART NUMBER FROM SPECS ON PAGES 2 THRU 6.

### 2 ACCESSORIES

- GFI15** (15 amp GFCI receptacle outlet) 
- GFI20** (20 amp GFCI receptacle outlet)
- GFI-WPU** (20 amp GFCI receptacle with weather proof in-use cover)
- BAA** (Cast Banner Arm A for 24" wide banner) 
- BAB** (Cast Banner Arm B for 30" wide banner) 
- BAC** (Cast Banner Arm C for 30" wide banner) 
- LR1** (Cast Ladder Rest 1) 
- LR3** (Cast Ladder Rest 3) 
- LR4** (Cast Ladder Rest 4) 
- LR5** (Cast Ladder Rest 5) 
- SIGN A** (Cast Sign A; 30" x 9", 8 letters/numbers on one line; requires Banner Arm to hang) 
- SIGN B** (Cast Sign B; 31" x 7", 12 letters/numbers on one line; requires Banner Arm to hang) 
- SIGN C** (Cast Sign C; 27" x 11", two rows of 8 letters/numbers on each line, requires Banner Arm to hang) 
- SIGN D** (Cast Sign D; 11" x 6 1/2", 4 letters/numbers on one line) 
- SIGN E** (Cast Sign E; comes with pole clamp, 24 1/2" x 6", 9 letters/numbers on one line) 
- FPH1** (Flag Pole Holder) 
- TP** (Tamper Proof Screws)

### 3 FINISHES

Standard Grade	Marine Grade		Standard Grade	Marine Grade	
40	NA	Raw Unfinished	53	100	Copper Clay
41	101	Black	56	109	Silver
42	102	Forest Green	61	106	Black Verde
43	114	Bright Red	70	118	Painted Chrome
44	107	White	71	105	Painted Copper
45	112	Bright Blue	72	108	Textured Black
46	123	Sunny Yellow	73	125	Matte Black
47	120	Aqua Green	76	121	Textured Architectural Bronze
49	NA	Galvanized	77	127	Textured White
50	111	Navy	78	124	Textured Silver
51	103	Architectural Bronze	10	130	Aspen Green
52	104	Patina Verde	11	131	Cantaloupe
12	133	Lilac	13	132	Putty

Consult factory for additional paint charges and availability

Project: \_\_\_\_\_

Fixture Type: \_\_\_\_\_ Quantity: \_\_\_\_\_

Customer: \_\_\_\_\_

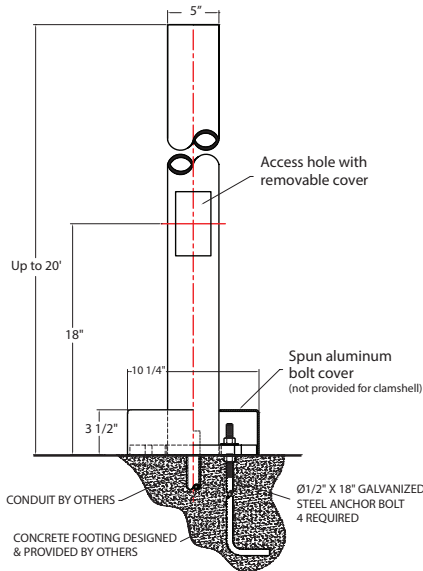

Mounting slot for Ø1/2" anchor bolt. 4 required

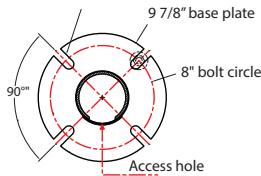

**MOUNTING DETAIL**

Various heights and fixture configurations may require a different bolt circle. Consult factory for specific bolt circle required.

**SMOOTH BOLT DOWN POLE OPTIONS**

Item Number	OD	Height	Wall	80 MPH	100 MPH
BD5S6	5	6	0.125	30.10	18.30
BD5S7	5	7	0.125	26.50	16.20
BD5S8	5	8	0.125	23.00	13.90
BD5S9	5	9	0.125	20.10	12.20
BD5S10	5	10	0.125	17.20	10.40
BD5S11	5	11	0.125	15.00	9.10
BD5S12	5	12	0.125	12.90	7.80
BD5S13	5	13	0.125	11.30	6.70
BD5S14	5	14	0.125	9.70	5.90
BD5S15	5	15	0.125	8.50	5.10
BD5S16	5	16	0.125	7.30	4.40
BD5S17	5	17	0.125	6.40	3.70
BD5S18	5	18	0.125	5.50	3.30
BD5S19	5	19	0.125	4.80	2.90
BD5S20	5	20	0.125	4.10	2.50
BD5S7	5	7	0.188	35.30	21.60
BD5S8	5	8	0.188	30.60	18.50
BD5S9	5	9	0.188	26.80	16.00
BD5S10	5	10	0.188	22.90	13.90
BD5S11	5	11	0.188	19.70	12.20
BD5S12	5	12	0.188	16.80	10.40
BD5S13	5	13	0.188	14.80	8.90
BD5S14	5	14	0.188	12.90	7.60
BD5S15	5	15	0.188	11.30	6.80
BD5S16	5	16	0.188	9.70	5.80
BD5S17	5	17	0.188	8.50	4.90
BD5S18	5	18	0.188	7.40	4.40
BD5S19	5	19	0.188	6.40	3.80
BD5S20	5	20	0.188	5.50	3.30

**Material**

Aluminum pole bases and base plates shall be cast from 356 aluminum alloy. Shafts shall be extruded 6061-T6 aluminum. Available in 5" diameter. Wall thickness 0.125" or 0.188".

**Mounting**

Four anchor bolts provided are 1/2"x18" or 3/4"x18" depending on the pole height, fixture weight and mounting weight. Anchor bolts, nuts and washers are hot dipped galvanized steel. Spun aluminum bolt cover provided.

**Access**

All poles are provided with a hand access opening and cover. Hand hole cover is secured by two stainless steel machine screws. (Tamper-proof screws provided upon request).

**Grounding**

All poles are provided with an aluminum grounding lug integrated to inner wall of shaft, 180 degrees to hand hole. Grounding lug is drilled and tapped to accommodate 1/4"-20 stainless steel machine screw.

**Pole Height**

Maximum pole height is 20-feet.

**Accessories**

Banner arms, ladder rests, signage, flag pole holder and GFI receptacles are optional.

**Finish**

A polyester powder coat high quality finish is electro-statically applied and baked at 430° for exceptional durability and color retention. Products undergo an intensive five-step cleansing and pretreatment process for maximum paint adhesion.

Marine grade finish provides superior salt, humidity, and UV protection. This coating withstands up to 3000 hours of continuous salt spray, comes with a 5-year warranty and is available in either a textured or gloss surface.

Project: \_\_\_\_\_

Fixture Type: \_\_\_\_\_ Quantity: \_\_\_\_\_

Customer: \_\_\_\_\_

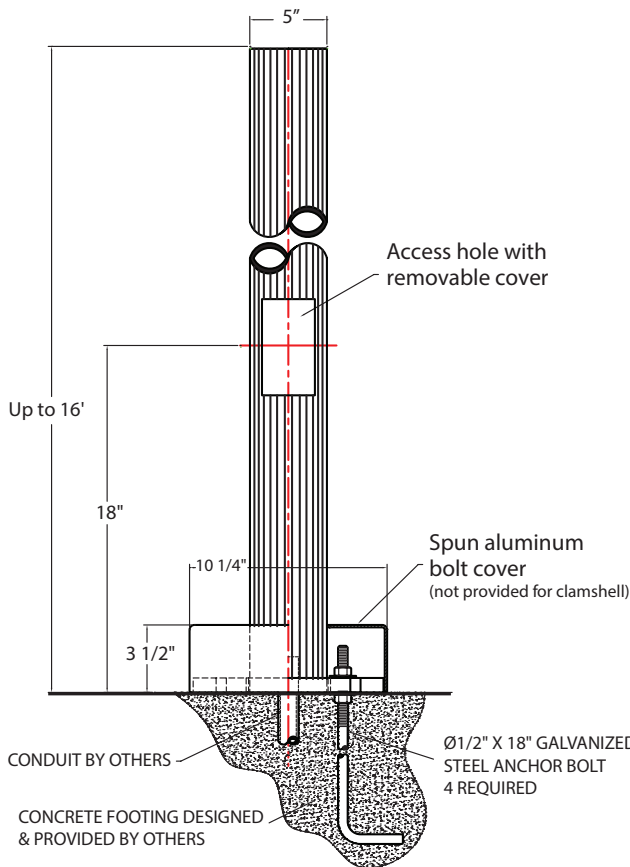

FLUTED BOLT DOWN POLE OPTIONS			
Item Number	OD	Height	Wall
BD5F10-.188	5.00"	10'	.188
BD5F11-.188	5.00"	11'	.188
BD5F12-.188	5.00"	12'	.188
BD5F13-.188	5.00"	13'	.188
BD5F14-.188	5.00"	14'	.188
BD5F15-.188	5.00"	15'	.188
BD5F16-.188	5.00"	16'	.188

Mounting slot for  $\varnothing 1/2"$  anchor bolt. 4 required

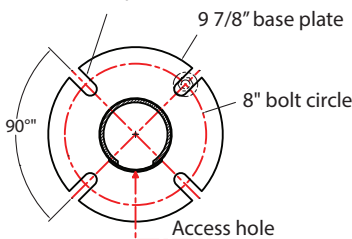

### MOUNTING DETAIL

Various heights and fixture configurations may require a different bolt circle. Consult factory for specific bolt circle required.

### Material

Aluminum pole bases and base plates shall be cast from 356 aluminum alloy. Shafts shall be extruded 6061-T6 aluminum. Available in 5" diameter. Wall thickness 0.125" or 0.188".

### Mounting

Four anchor bolts provided are  $1/2"$ x18" or  $3/4"$ x18" depending on the pole height, fixture weight and mounting weight. Anchor bolts, nuts and washers are hot dipped galvanized steel. Spun aluminum bolt cover provided.

### Access

All poles are provided with a hand access opening and cover. Hand hole cover is secured by two stainless steel machine screws. (Tamper-proof screws provided upon request) 1-1/2"  $\varnothing$  wireway hole provided on same side as access hole

### Grounding

All poles are provided with an aluminum grounding lug integrated to inner wall of shaft, 180 degrees to hand hole. Grounding lug is drilled and tapped to accommodate  $1/4"$ -20 stainless steel machine screw.

### Pole Height

Maximum pole height is 16-feet.

### Accessories

Banner arms, ladder rests, signage, flag pole holder and GFI receptacles are optional.

### Finish

A polyester powder coat high quality finish is electro-statically applied and baked at 430° for exceptional durability and color retention. Products undergo an intensive five-step cleansing and pretreatment process for maximum paint adhesion.

Marine grade finish provides superior salt, humidity, and UV protection. This coating withstands up to 3000 hours of continuous salt spray, comes with a 5-year warranty and is available in either a textured or gloss surface.

Project: \_\_\_\_\_

Fixture Type: \_\_\_\_\_ Quantity: \_\_\_\_\_

Customer: \_\_\_\_\_

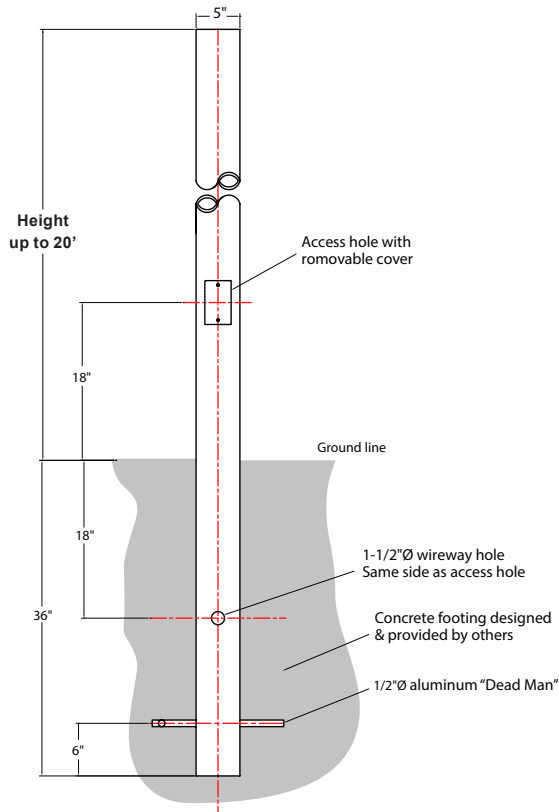

SMOOTH DIRECT BURIAL POLE OPTIONS			
Item Number	OD	Height	Wall
DB5S6	5	6	0.125
DB5S7	5	7	0.125
DB5S8	5	8	0.125
DB5S9	5	9	0.125
DB5S10	5	10	0.125
DB5S11	5	11	0.125
DB5S12	5	12	0.125
DB5S13	5	13	0.125
DB5S14	5	14	0.125
DB5S15	5	15	0.125
DB5S16	5	16	0.125
DB5S17	5	17	0.125
DB5S18	5	18	0.125
DB5S19	5	19	0.125
DB5S20	5	20	0.125
DB5S7	5	7	0.188
DB5S8	5	8	0.188
DB5S9	5	9	0.188
DB5S10	5	10	0.188
DB5S11	5	11	0.188
DB5S12	5	12	0.188
DB5S13	5	13	0.188
DB5S14	5	14	0.188
DB5S15	5	15	0.188
DB5S16	5	16	0.188
DB5S17	5	17	0.188
DB5S18	5	18	0.188
DB5S19	5	19	0.188
DB5S20	5	20	0.188

**Material**

Aluminum pole shall be extruded 6061-T6 aluminum. Available in 5" diameter. Wall thickness 0.125" or 0.188".

**Mounting**

Concrete footing designed and provided by others. A 1/2"Ø aluminum "Dead Man" is provided.

**Access**

All poles are provided with a hand access opening and cover. Hand hole cover is secured by two stainless steel machine screws. (Tamper-proof screws provided upon request). 1-1/2"Ø wireway hole provided on same side as access hole.

**Grounding**

All poles are provided with an aluminum grounding lug integrated to inner wall of shaft, 180 degrees to hand hole. Grounding lug is drilled and tapped to accommodate 1/4"-20 stainless steel machine screw.

**Pole Height**

Maximum pole height is 20-feet.

**Accessories**

Banner arms, ladder rests, signage, flag pole holder and GFI receptacles are optional.

**Finish**

A polyester powder coat high quality finish is electro-statically applied and baked at 430° for exceptional durability and color retention. Products undergo an intensive five-step cleansing and pretreatment process for maximum paint adhesion.

Marine grade finish provides superior salt, humidity, and UV protection. This coating withstands up to 3000 hours of continuous salt spray, comes with a 5-year warranty and is available in either a textured or gloss surface.

Project: \_\_\_\_\_

Fixture Type: \_\_\_\_\_ Quantity: \_\_\_\_\_

Customer: \_\_\_\_\_

FLUTED DIRECT BURIAL POLE OPTIONS			
Item Number	OD	Height	Wall
DB5F10-.188	5.00"	10'	.188
DB5F11-.188	5.00"	11'	.188
DB5F12-.188	5.00"	12'	.188
DB5F13-.188	5.00"	13'	.188
DB5F14-.188	5.00"	14'	.188
DB5F15-.188	5.00"	15'	.188
DB5F16-.188	5.00"	16'	.188

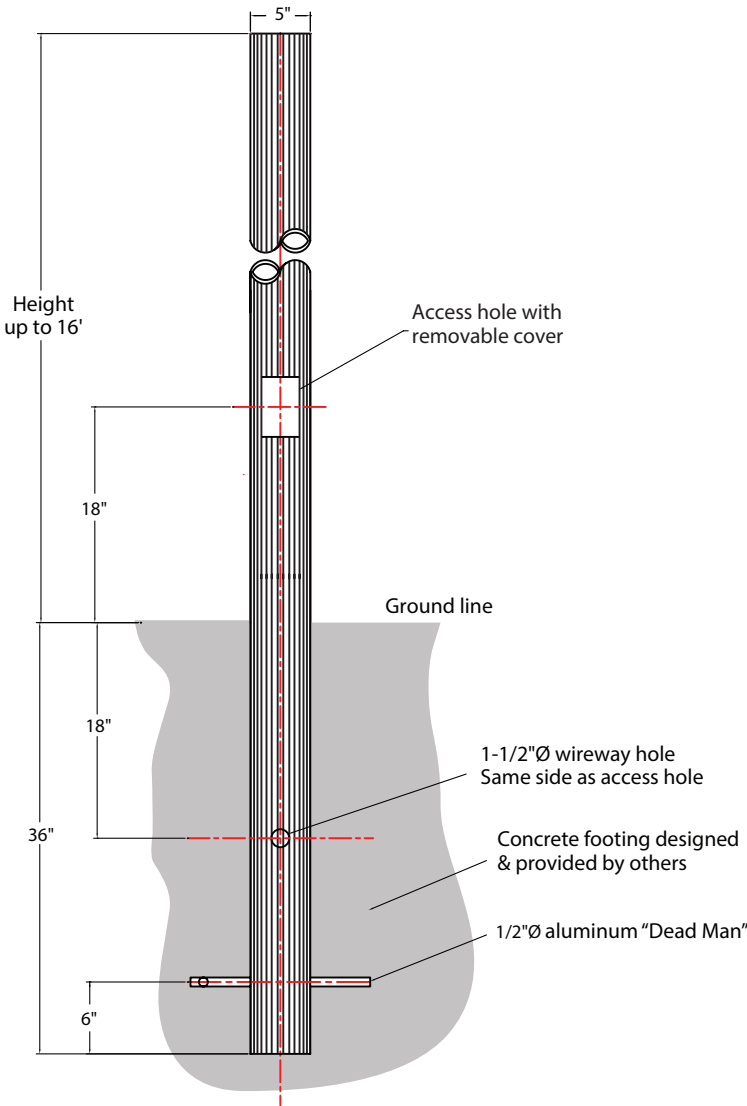

**Material**

Aluminum pole shall be extruded 6061-T6 aluminum. Available in 5" diameter. Wall thickness 0.125" or 0.188".

**Mounting**

Concrete footing designed and provided by others. A 1/2"Ø aluminum "Dead Man" is provided.

**Access**

All poles are provided with a hand access opening and cover. Hand hole cover is secured by two stainless steel machine screws. (Tamper-proof screws provided upon request) 1-1/2"Ø wireway hole provided on same side as access hole

**Grounding**

All poles are provided with an aluminum grounding lug integrated to inner wall of shaft, 180 degrees to hand hole. Grounding lug is drilled and tapped to accommodate 1/4"-20 stainless steel machine screw.

**Pole Height**

Maximum pole height is 16-feet.

**Accessories**

Banner arms, ladder rests, signage, flag pole holder and GFI receptacles are optional.

**Finish**

A polyester powder coat high quality finish is electro-statically applied and baked at 430° for exceptional durability and color retention. Products undergo an intensive five-step cleansing and pretreatment process for maximum paint adhesion.

Marine grade finish provides superior salt, humidity, and UV protection. This coating withstands up to 3000 hours of continuous salt spray, comes with a 5-year warranty and is available in either a textured or gloss surface.