

Project: _____

Fixture Type: _____ Quantity: _____

Customer: _____

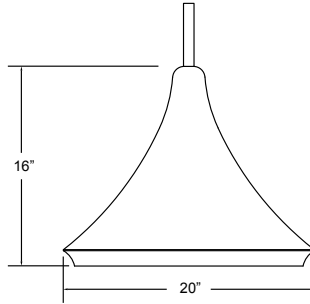

Specifications

Material:
Shades are constructed of heavy duty spun aluminum.

Lens:
Flat, 72% transmission white acrylic lens, 0.059" thick is standard.

Electrical:
Universal voltage 120-277 is standard. 0-10V, TRIAC and ELV dimming to 1% protocols are standard for LED modules.

See page 2 table for LED module and driver specs, voltage and dimming protocols.

Certifications:
UL Listed for dry locations.

Finish:
A polyester powder coat high quality finish is electro-statically applied and baked at 430° for exceptional durability and color retention. Products undergo an intensive five-step cleansing and pretreatment process for maximum paint adhesion.

For black or white cord - canopy finish and cord grip finish will match cord color.

For color cord - canopy finish and cord grip finish will match shade finish.

Consult factory for other options.

Modifications:
Consult factory for custom or modified designs.

MDA20 LED

Weight: 5.0 lbs

Catalog Logic

MDA20 - M016LDDW - 27K - CRD-DCCEM - BLSF - EMG-LED16 - 56 - UNV



Catalog Number		1	2	3	4	5	6	7
		MDA20						UNV

1 LIGHT SOURCE & WATTAGES

M009LDDW	(9w, 850 lumen, Cree module)
M010LDDW	(10w, 1250 lumen, Cree module)
M016LDDW	(16w, 2000 lumen, Cree module)

2 COLOR TEMPERATURE (CCT)

27K	(2700K)
30K	(3000K)
35K	(3500K)
40K	(4000K)

3 DRIVER HOUSINGS*
(Driver Housing only Required with Color Cord and/or Emergency Backup Options)

NA No selection is required if Color Cord or Emergency Backup are not chosen

Color Cord Driver Housing Options
Choose Color Cord Style in Box 4

CRD-DCC (Driver Housing for Color Cord only; 7 3/4" x 1 1/2")

SSC-DCC (Driver Housing for SS Cable/Color Cord only; 7 3/4" x 1 1/2")

Emergency Backup Driver Housing Options

CRD-DCCEM-BLC (Emergency Ballast Housing for Black Cord only; 12" x 1 1/2")
Choose **NA** in Box 4

CRD-DCCEM-WHC (Emergency Ballast Housing for White Cord only; 12" x 1 1/2")
Choose **NA** in Box 4

CRD-DCCEM (Emergency Ballast Housing for Color Cord only; 12" x 1 1/2")
Choose **Color Cord Style** in Box 4

ST-DCCEM (Emergency Ballast Housing for Stem only; 12" x 1 1/2")
Choose **Stem Size** in Box 4

SSC-DCCEM-BLC (Stainless steel cable with 6-foot black cord and 12" canopy)
Choose **NA** in Box 4

SSC-DCCEM-WHC (Stainless steel cable with 6-foot white cord and 12" canopy)
Choose **NA** in Box 4

SSC-DCCEM (Emergency Ballast Housing for SS Cable/Color Cord only; 12" x 1 1/2")
Choose **Color Cord Style** in Box 4

*Driver Housing finish will match fixture finish.

4 MOUNTING SOURCES*

Cable Mounts
(See page 3 for color cord style)

SSC-BLC-5W (Stainless steel cable with 6-foot black cord and 5 3/8" canopy)

SSC-WHC-5W (Stainless steel cable with 6-foot white cord and 5 3/8" canopy)

Cord Mounts
(See page 3 for color cord style)

NA No Selection Required if:
CRD-DCCEM-BLC; CRD-DCCEM-WHC; SSC-DCCEM-BLC or SSC-DCCEM-WHC is chosen in Box 3.

SJT Cord

BLC-5W (6' Black 5-wire SJT Cord)	WHC-5W (6' White 5-wire SJT Cord)
--	--

Solid Fabric Colored Cords
Must Choose DCC Housing in Box 3

BLSF (6' Black)	ORSF (6' Orange)
GYSF (6' Gray)	LGSF (6' Lime Green)
CHSF (6' Chocolate Brown)	KGSF (6' Kelly Green)
WHSF (6' White)	CBSF (6' Cobalt Blue)
CASF (6' Cardinal)	SBSF (6' Sky Blue)

Patterned Fabric Colored Cords
Must Choose DCC Housing in Box 3

BWHPF (6' Black/White Houndstooth)	BIHPF (6' Brown/Ivory Houndstooth)
GYCPF (6' Gray/Citrus Yellow)	MOSPF (6' Magenta/Orange Stripe)
NMTPF (6' Navy Mini Tweed)	

Glossy Fabric Colored Cords
Must Choose DCC Housing in Box 3

GMGF (6' Gun Metal)	SSGF (6' Sterling Silver)
CPGF (6' Copper Penny)	BRGF (6' Bronze)
GOGF (6' Gold)	

4 MOUNTING SOURCES (Continued)*

Stem Mounts

1/4" (1/2" OD Stems with 45° Swivel Flat Canopy)

1STS6 1STS12 1STS18 1STS24 1STS36 1STS48

1STS60 1STS72 1STS96

1/4" (1/2" OD Rigid Stems with Flat Canopy)

1STR6 1STR12 1STR18 1STR24 1STR36

1STR48 1STR60 1STR72 1STR96

*Arm mount, Wall mount or Stem finish will match fixture finish.

5 ACCESSORIES

***EMG-LED06** (6w, LED Emergency Driver, remote placement, Cree module only, Not applicable for 12w LED)
MUST CHOOSE DCCEM CANOPY IN BOX 3.

***EMG-LED10** (10w, LED Emergency Driver, remote placement, Cree module only, Not applicable for 12w LED)
MUST CHOOSE DCCEM CANOPY IN BOX 3.

***EMG-LED16** (16w, LED Emergency Driver, remote placement, Cree module only, Not applicable for 12w LED)
MUST CHOOSE DCCEM CANOPY IN BOX 3.

*For Emergency lumen output data, see Technical section at www.ANPlighting.com

Project: _____

Fixture Type: _____ Quantity: _____

Customer: _____

6 FINISHES
*Marine Grade Finish has an additional charge

Standard Colors	Standard Grade	Marine Grade*	Premium Colors	Premium Grade	Marine Grade*
Aspen Green	10	10M	High Gloss Black	01	01M
Cantaloupe	11	11M	Arctic Silver	14	14M
Lilac	12	12M	Candy Apple Red	64	64M
Putty	13	13M	Cobalt Blue	65	65M
Raw Unfinished	40	NA	Caramel	66	66M
Black	41	41M	Butterscotch	67	67M
Forest Green	42	42M	Black Silver	68	68M
Bright Red	43	43M	Gunmetal Gray	69	69M
White	44	44M	Mayan Gold	79	NA
Bright Blue	45	45M	Textured Desert Stone	80	80M
Sunny Yellow	46	46M	Extreme Chrome	81	81M
Aqua Green	47	47M	Graystone	82	82M
Galvanized	49	NA	Oil Rubbed Bronze	83	83M
Navy	50	50M	Carbon Graphite	96	96M
Architectural Bronze	51	51M			
Patina Verde	52	52M			
Copper Clay	53	53M			
Silver	56	56M			
Black Verde	61	61M			
Painted Chrome	70	70M			
Painted Copper	71	71M			
Textured Black	72	72M			
Matte Black	73	73M			
Textured Architectural Bronze	76	76M			
Textured White	77	77M			
Textured Silver	78	78M			

Consult Factory for additional paint charges and availability.

7 VOLTAGE

UNV (120 - 277)

LED MODULE SPECIFICATIONS

LED Wattage	CCT	Typical Luminous Flux	System Wattage	Typical Efficacy
9W	2700K	850	11W	97
	3000K	850	11W	97
	3500K	850	11W	97
	4000K	850	11W	97
10W	2700K	1250	12W	125
	3000K	1250	12W	125
	3500K	1250	12W	125
	4000K	1250	12W	125
16W	2700K	2000	19W	125
	3000K	2000	19W	125
	3500K	2000	19W	125
	4000K	2000	19W	125

MODULE SPECIFICATION:

- Efficacy 65-125 lumens per watt
- Life: L70 50,000 hours
- Color temp: 2700K, 3000K, 3500K and 4000K
- CRI: >90

MODULE LISTINGS

- Fully compliant with the RoHS Directive
- Certifications: CE/UL

MODULE DRIVER SPECIFICATION:

- Input Voltage: 120-277 Volts; 50/60Hz
- Dimmable down to 1%
- 0-10V, TRIAC and ELV dimming protocols are standard.
- Output Current: Constant Current; 440mA to 940mA (model dependent)
- Driver Efficiency > 80%; Power Factor > 0.9
- Integral Surge Protection in conformance to ANSI C62.41 Category A.

WARRANTY





See www.ANPlighting.com for complete fixture warranty.

LED warranty information

- 5 year limited warranty*

*Limited Warranty: A typical year is defined as 4380 hours of operation

Driver Housings

	CRD-DCC (7 3/4" x 1 1/2") Cord Only
	SSC-DCC (7 3/4" x 1 1/2") Cable/Cord Only
	ST-DCCEM (12" x 1 1/2") Stem Only
	CRD-DCCEM (12" x 1 1/2") Cord Only
	SSC-DCCEM (12" x 1 1/2") Cable/Cord Only

Project: _____

Fixture Type: _____ Quantity: _____

Customer: _____

All fabric Color Cords are three conductor, 1/4" diameter

Solid Fabric Colored Cords



BLSF | Black



GYSF | Gray



CHSF | Chocolate Brown



WHSF | White

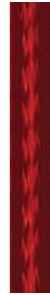

CASF | Cardinal



ORSF | Orange



LGSF | Lime Green



KGSF | Kelly Green



CBSF | Cobalt Blue



SBSF | Sky Blue

Patterned Fabric Colored Cords



BWHPF | Black/White Houndstooth



BIHPF | Brown/Ivory Houndstooth



GYCPF | Gray/Citrus Yellow



MOSPF | Magenta/Orange Stripe



NMTPF | Navy Mini Tweed

Glossy Fabric Colored Cords



GMGF | Gun Metal



SSGF | Sterling Silver



CPGF | Copper Penny



BRGF | Bronze



GOGF | Gold