

Project: _____
 Fixture Type: _____ Quantity: _____
 Customer: _____

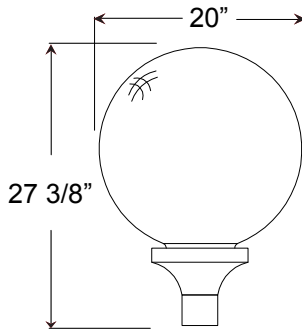

Specifications

Fitter:
 Fitter is durable 356 cast aluminum. All hardware provided shall be stainless steel or zinc plated steel.

Round Globe:
 Round Globes are available in clear, frosted and white polycarbonate material.

Fixture Mounting:
 Post Mount: Post Cap with set screws. Fits 3" and 4" poles.

Drivers:
 Universal voltage 120-277 is standard. 0-10V, TRIAC and ELV dimming to 1% protocols are standard for LED modules.

See page 2 table for LED module and driver specs, voltage and dimming protocols



Electrical:
 Approximately 12" of pull wire extends from luminaire. Additional pull wire provided for post mount arms and wall mounts.

Finish:
 A polyester powder coat high quality finish is electro-statically applied and baked at 430° for exceptional durability and color retention. Products undergo an intensive five-step cleansing and pretreatment process for maximum paint adhesion.

Marine grade finish provides superior salt, humidity and UV protection. This coating withstands up to 3000 hours of continuous salt spray, comes with a 5-year warranty and is available in either a textured or gloss surface.

Modifications:
 Consult factory for custom or modified designs.

LF3020

Weight: 19 lbs
 EPA: 1.26

Catalog Logic

LF3020 **95** **CL** **M016LD** **D** **T5** **40K** **- PC** **- FIN02** **- WM2141** **- 72**
 Luminaire Series Cage Lens Light Source & Wattage Dimming Optic CCT Accessories Finial Mounting Finish

Catalog Number									
1	2	3	4	5	6	7	8	9	10
LF3020			D						

1 **OPTIONAL CAGE**
 See Page 3 for Style/Design

CAGE: 95

2 **LENS**

CL (Clear Polycarbonate Sphere)
FR (Frosted Polycarbonate Sphere)
WH (White Polycarbonate Sphere)

3 **LIGHT SOURCE & WATTAGES**

M009LD (9w, 850 lumen, Cree module)
M010LD (10w, 1250 lumen, Cree module)
M012LD (12w, 750 lumen, Cree module) Integral driver, 120V, Triac dimming & narrow distribution only.
M016LD (16w, 2000 lumen, Cree module)
M024LD (24w, 3000 lumen, Cree module)
M037LD (37w, 4000 lumen, Cree module)

4 **DIMMING**

D (Dimming)

See page 2 for LED Module dimming protocols and limitations.

5 **OPTICS**

W (T5 Wide Distribution with Dome LED Lens)
N* (T5 Narrow Distribution with Flat LED Lens)

*12w is narrow only, select "N".

6 **COLOR TEMPERATURE (CCT)**

Module	
27K	(2700K)
30K	(3000K)
35K	(3500K)
40K	(4000K)

7 **ACCESSORIES**

HSS90 (90° House Side Shield, polished)
HSS120 (120° House Side Shield, polished)
PHSS90 (90° House Side/Uplight Shield, polished)
PHSS120 (120° House Side/Uplight Shield, polished)
*EMG-LED5 (5w, LED Emergency Driver, remote placement, Cree module only)
*EMG-LED7 (7w, LED Emergency Driver, remote placement, Cree module only)
*EMG-LED10 (10w, LED Emergency Driver, remote placement, Cree module only)
HLMSPC-06 (High-Low Motion Sensor/Photocell; 15' - 30' Sensor Mounting Height)
HLMSPC-10 (High-Low Motion Sensor/Photocell; 8' - 15' Sensor Mounting Height)
PC (Button Photo Cell)
RNR (Reinforcing Neck Ring)
SP (Surge Protector, 10kA & 10kV)
TLPC (Twist Lock photo cell, includes receptacle & photo cell)
TL (Twist Lock receptacle only)
TL5 (5-pin Twist Lock receptacle)
TL7 (7-pin Twist Lock receptacle)

*For Emergency lumen output data, see Resources section at www.ANPlighting.com.

8 **OPTIONAL FINIALS**
 *See Page 4 for Style/Size

FIN02, FIN04, FIN05, FIN06, FIN10, FIN12, FIN15, FIN18, FIN28, FIN39, FIN41, FIN42, FIN48, FIN64, FIN70

9 **MOUNTING SOURCE**

Post Mount Arms *See Page 4 for Style/Size		Wall Mount Arms *See Page 4 for Style/Size	
PA5151	PA8711	WM2141	WM8581
PA5171	PA8831	WM2211	WM8831
PA5411		WM3351	
PA5621		WM4511	
PA5651		WM5131	
PA6211		WM5161	
PA7911		WM5311	
PA8031		WM5601	
PA8521		WM7411	
PA8571		WM8011	
Column Mount *See Page 4 for Style/Size			
CM	Column Mount		

10 **FINISHES**

Standard Grade	Marine Grade	Standard Grade	Marine Grade
40	NA Raw Unfinished	53	100 Copper Clay
41	101 Black	56	109 Silver
42	102 Forest Green	61	106 Black Verde
43	114 Bright Red	70	118 Painted Chrome
44	107 White	71	105 Painted Copper
45	112 Bright Blue	72	108 Textured Black
46	123 Sunny Yellow	73	125 Matte Black
47	120 Aqua Green	76	121 Textured Architectural Bronze
49	NA Galvanized	77	127 Textured White
50	111 Navy	78	124 Textured Silver
51	103 Architectural Bronze	10	130 Aspen Green
52	104 Patina Verde	11	131 Cantaloupe
12	133 Lilac	13	132 Putty

Consult factory for additional paint charges and availability

Project: _____
 Fixture Type: _____ Quantity: _____
 Customer: _____

LED PERFORMANCE				
MODULE				
LED Wattage	CCT	Typical Luminous Flux	System Wattage	Typical Efficacy
9W	2700K	850	11W	97
	3000K	850	11W	97
	3500K	850	11W	97
	4000K	850	11W	97
10W	2700K	1250	12W	125
	3000K	1250	12W	125
	3500K	1250	12W	125
	4000K	1250	12W	125
12W	2700K	750	12W	65
	3000K	750	12W	65
	3500K	750	12W	65
	4000K	750	12W	65
16W	2700K	2000	19W	125
	3000K	2000	19W	125
	3500K	2000	19W	125
	4000K	2000	19W	125
24W	2700K	3000	28W	125
	3000K	3000	28W	125
	3500K	3000	28W	125
	4000K	3000	28W	125
37W	2700K	4000	43W	108
	3000K	4000	43W	108
	3500K	4000	43W	108
	4000K	4000	43W	108

MODULE SPECIFICATION
<ul style="list-style-type: none"> Efficacy 65-125 lumens per watt Life: L70 50,000 hours Color temp: 2700K,3000K,3500K and 4000K CRI: >90

MODULE DRIVER SPECIFICATION
<ul style="list-style-type: none"> Input Voltage: 120-277 Volts; 50/60Hz Dimmable down to 1% 0-10V, TRIAC and ELV dimming protocols are standard. Output Current: Constant Current: 440mA to 940mA (model dependent) Driver Efficiency > 80%; Power Factor > 0.9 Integral Surge Protection in conformance to ANSI C62.41 Category A

MODULE LISTINGS
<ul style="list-style-type: none"> Fully compliant with the RoHS Directive Certifications: CE/UL

WARRANTY
<p>See www.ANPlighting.com for complete fixture warranty.</p> <ul style="list-style-type: none"> 5 year limited warranty on Modules/Drivers <p>*Limited Warranty: A typical year is defined as 4380 hours of operation.</p>

Project: _____
Fixture Type: _____ Quantity: _____
Customer: _____

CAGE



CAGE 95

ACCESSORIES



HSS90 & HSS120



PHSS90 & PHSS120



EMG-LED 5w/7w/10w



HLMSPC-06 & HLMSPC-10



PC



RNR



TLPC



TL



TL5 & TL7

Project: _____
 Fixture Type: _____ Quantity: _____
 Customer: _____

FINIALS

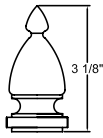

FIN02

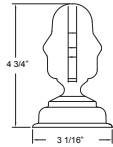

FIN04

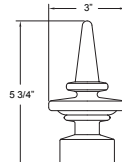

FIN05

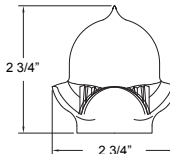

FIN06

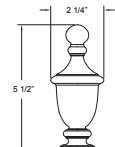

FIN10

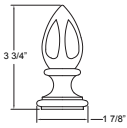

FIN12

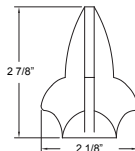

FIN15

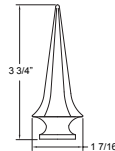

FIN18

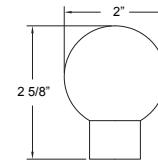

FIN28

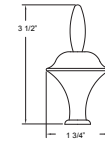

FIN39

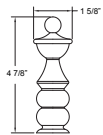

FIN41

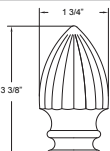

FIN42

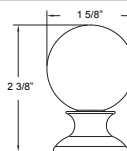

FIN48

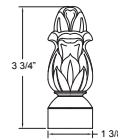

FIN64

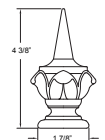

FIN70

POST MOUNTS - See Post Arm Section on Website for Specification Sheets and additional post arms.
 Dimensions are Projection x Height



PA5151 / 14 1/4" x 19 3/4"



PA5171 / 15 1/4" x 25 5/8"



PA5411 / 17 7/8" x 25 1/8"



PA5621 / 19" x 26 1/4"



PA5651 / 20" x 26 1/4"



PA6211 / 22 3/4" x 26 1/2"



PA7911 / 20" x 20 5/8"



PA8031 / 20 1/2" x 20 1/4"



PA8521 / 18 1/4" x 14 1/2"



PA8571 / 24" x 47"



PA8711 / 20" x 20 3/8"



PA8831 / 18 7/8" x 18 7/8"

COLUMN MOUNT



CM / 5 3/4" SQ x 3 1/2" H

WALL MOUNTS - See Wall Mount Section on Website for Specification Sheets and additional wall mount arms.
 Dimensions are Projection x Height.

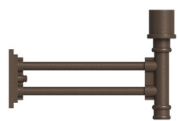

WM2141 / 18" x 12 3/16"



WM2211 / 15 1/2" x 15 7/8"



WM3351 / 14 1/2" x 22"

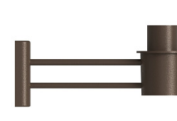

WM4511 / 17" x 8"



WM5131 / 11" x 16 3/8"



WM5161 / 15 3/4" x 17 3/4"



WM5311 / 10 7/8" x 9 3/4"



WM5601 / 17 7/8" x 14"



WM7411 / 14" x 15 3/4"



WM8011 / 18 1/4" x 16 3/8"



WM8581 / 17 1/8" x 17 1/2"



WM8831 / 17 1/4" x 16 3/8"