

Project: _____

Fixture Type: _____ Quantity: _____

Customer: _____



Specifications

Material:
Constructed of complete cast aluminum. All hardware provided shall be stainless steel. Screw hardware may not match paint.

Glass:
Choice of clear, frosted or prismatic glass. Colored glass available for extra charge.

Ballasts:
Fluorescent Ballast will be electronic. Fluorescent sockets will be 4 pin to accept quad or triple tube lamps.

Electrical:
4-Pin Socket; Multi-tap 120v, 208v, 240v & 277v.

Finish:
A polyester powder coat high quality finish is electro-statically applied and baked at 430° for exceptional durability and color retention. Products undergo an intensive five-step cleansing and pretreatment process for maximum paint adhesion.

Marine grade finish provides superior salt, humidity and UV protection. This coating withstands up to 3000 hours of continuous salt spray, comes with a 5-year warranty and is available in either a textured or gloss surface.

Certifications:
Cord mounts are UL Listed for dry locations. Arm, wall, post, pendant and stem mounts are UL Listed for wet locations.

Modifications:
Consult factory for custom or modified designs.

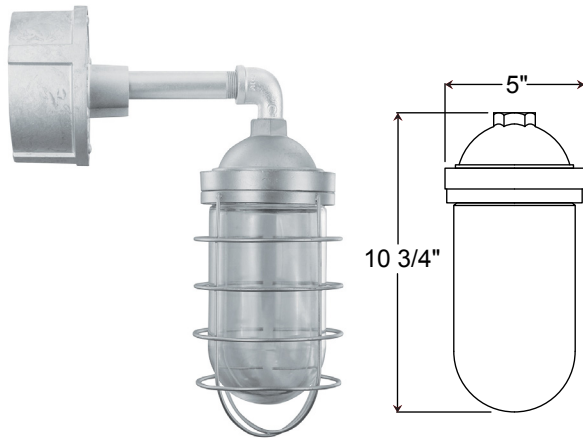

VTP200GL CFL

Weight: 3 lbs

Catalog Logic

VTP200GL	-	CL	-	42WPL	-	RTCNC	-	E22	-	GUP	-	NA	-	PC	-	120v	-	49
Vapor Tight Style		Glass		Light Source/Wattage		Ballast Housing		Mounting Source		Guard		Shade Accessories		Accessories		Voltage		Finish

Catalog Number		1	2	3	4	5	6	7	8	9								
VTP200GL	-	CL	-	42WPL	-	RTCNC	-	E22	-	GUP	-	NA	-	PC	-	120v	-	49

1	GLASS
NA	(No Glass)
CL	(Clear Glass)
FR	(Frosted Glass)
PR	(Prismatic Glass)
BLU	(Blue Glass)
AMB	(Amber Glass)
GRN	(Green Glass)
RED	(Red Glass)

2	LIGHT SOURCE & WATTAGES
	Flourescent (WPL)
	GU24 Socket Option
	26WPL
	32WPL
	42WPL
	26WPLDIM
	32WPLDIM
	42WPLDIM
	(Compact Fluorescent dimming is 0-10v and ballast must be located within 12" of lamp)

3	BALLAST HOUSING
	Flourescent (WPL)
	RTC (WPL Ballast Canopy)
	RTCNC (WPL Ballast Canopy/No Spun Cover)
	DBH (Dimming WPL Ballast Housing)

4	MOUNTING SOURCES
	Arm Mounts (Cast back plate included)
	E6 E9 E13 E22 E23 E24 E25 E26 E27 E36 E39
	Wall Mounts
	WM35
	WM40
	WM318
	Post Mounts
	PM10
	PM20
	Pendant Mounts
	2 Light Pendant 200w Vapor Tights
	22PEND6 22PEND12 22PEND18 22PEND24 22PEND36
	22PEND48 22PEND60 22PEND72 22PEND96
	3 Light Pendant 200w Vapor Tights
	32PEND6 32PEND12 32PEND18 32PEND24 32PEND36
	32PEND48 32PEND60 32PEND72 32PEND96
	4 Light Pendant 200w Vapor Tights
	42PEND6 42PEND12 42PEND18 42PEND24 42PEND36
	42PEND48 42PEND60 42PEND72 42PEND96

4	MOUNTING SOURCES CONT.
	Cord Mounts
	BLC (6' black cord with 1" x 5 3/8" canopy)
	WHC (6' white cord with 1" x 5 3/8" canopy)
	Stem Mounts
	3/4" (1"OD Rigid Stems with STC Flat Canopy)
	3ST6 3ST12 3ST18 3ST24 3ST36 3ST48
	3ST60 3ST72 3ST96

5	GUARD
	NA (No Guard)
	GUP (Wire Guard)
	GUPC (Cast Guard)

6	SHADE ACCESSORIES
	NA (No Accessory)
	VTS (9 3/4" Angle Ring)

WARRANTY
See www.anplighting.com for complete fixture warranty.

Project: _____

Fixture Type: _____ Quantity: _____

Customer: _____

7 ACCESSORIES	
CBC	(Cast back plate Spun Alum Cover)
PC	(Button Photo Cell) Remote Only
SC	(Scroll for Arms)
SLC	(Sloped Ceiling Mount)
SQ	(Square Back Plate)
SWL	(Swivel)
TBK	(Turnbuckle Kit)

8 VOLTAGES			
120	208	240	277

9 FINISHES					
Standard Grade	Marine Grade		Standard Grade	Marine Grade	
40	NA	Raw Unfinished	53	100	Copper Clay
41	101	Black	56	109	Silver
42	102	Forest Green	61	106	Black Verde
43	114	Bright Red	70	118	Painted Chrome
44	107	White	71	105	Painted Copper
45	112	Bright Blue	72	108	Textured Black
46	123	Sunny Yellow	73	125	Matte Black
47	120	Aqua Green	76	121	Textured Architectural Bronze
49	NA	Galvanized	77	127	Textured White
50	111	Navy	78	124	Textured Silver
51	103	Architectural Bronze	10	130	Aspen Green
52	104	Patina Verde	11	131	Cantaloupe
12	133	Lilac	13	132	Putty
Premium Grade	Marine Grade		Premium Grade	Marine Grade	
81	129	Extreme Chrome	64	116	Candy Apple Red
80	117	Textured Desert Stone	65	122	Cobalt Blue
67	119	Butterscotch	82	128	Graystone
66	115	Caramel	69	113	Gunmetal Gray
68	126	Black Silver			

Consult factory for additional paint charges and availability

Project: _____

Fixture Type: _____ Quantity: _____

Customer: _____



ARM MOUNTS | Dimensions are Projection x Height | CB included with all arms

 E6 26 1/8" x 9 1/4"	 E9 28" x 40 5/8"	 E13 34" x 34 3/8"	 E22 7 1/2" x 2"
 E23 6" x 2" x 11 1/2"	 E24 10" x 2"	 E25 23" x 5 1/4"	 E26 8 1/8" x 6"
 E27 10" x 2"	 E36 20 1/4" x 8"	 E39 10 1/2" x 15 1/8"	







WALL MOUNTS | Dimensions are Projection x Height | **POST MOUNTS** | Dimensions are Projection x Height

 WM35 20 1/2" x 25"	 WM40 13 7/8" x 14 3/4"	 PM10 14 1/2" x 25"	 PM20 30 1/8" x 25"
 WM318 12" x 12 3/4"			

PENDANT MOUNTS | xx is Height of Pendant Stem

 22PENDxx 14" w	 32PENDxx 28" w	 42PENDxx 28" x 28"	
--	--	--	--



ACCESSORIES

 CBC	 PC	 SC	 SLC
 SQ	 SWL	 TBK	

GLASS

 CL (Clear)	 FR (Frosted)
 PR (Prismatic)	 BLU (Blue)
 AMB (Amber)	 GRN (Green)
 RED (Red)	

GUARDS

 GUPC 200	 GUP 200
--	---

Ballast Housing

 RTC	
 RTCNC	
 DBH	