

Project: _____

Fixture Type: _____ Quantity: _____

Customer: _____

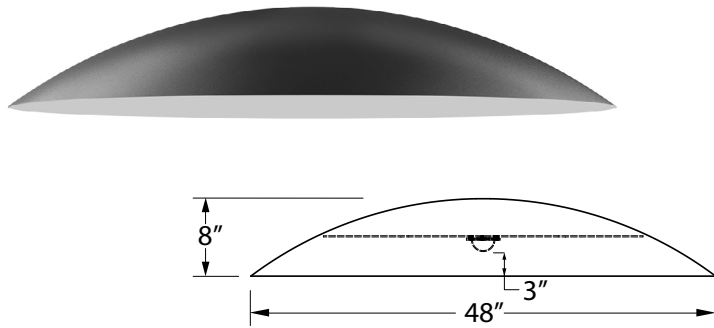

Specifications

Material:
RLM shades are constructed of heavy duty spun aluminum. Wall back plate and driver housing are cast aluminum. All fasteners are stainless steel. Inside of shade is reflective white finish for all colors except galvanized paint finish. Screw hardware may not match paint.

Glass:
Choice of clear, frosted or prismatic glass up to **24w Max optional**.

Electrical:
Universal voltage 120-277 is standard. 0-10V, TRIAC and ELV dimming to 1% protocols are standard for LED modules. (12w is 120v and TRIAC dimming only)

See page 2 table for LED module and driver specs, voltage and dimming protocols.

Certifications:
Cord mounts are UL Listed for dry locations. Arm mount, stem mount and wall mount are UL Listed for wet locations.

Finish:
A polyester powder coat high quality finish is electro-statically applied and baked at 430° for exceptional durability and color retention. Products undergo an intensive five-step cleansing and pretreatment process for maximum paint adhesion.

Marine grade finish provides superior salt, humidity and UV protection. This coating withstands up to 3000 hours of continuous salt spray, comes with a 5-year warranty and is available in either a textured or gloss surface.

Modifications:
Consult factory for custom or modified designs.

OSDC48 LED

Weight: 31.0 lbs

Catalog Logic

OSDC48 - M037LDD - W 40K - CRD-DCC - BLSF - 100GLCL - N/A - 41 - 44 - UNV

Catalog Number	1	2	3	4	5	6	7	8	9	10
OSDC48 -										UNV

1 LIGHT SOURCE & WATTAGES

M012LDD	(12w, 750 lumen, Cree module) Integral driver, 120V, TRIAC dimming & narrow distribution only.
M009LDD	(9w, 850 lumen, Cree module)
M010LDD	(10w, 1250 lumen, Cree module)
M016LDD	(16w, 2000 lumen, Cree module)
M024LDD	(24w, 3000 lumen, Cree module)
M037LDD	(37w, 4000 lumen, Cree module)

2 DISTRIBUTION

W	(T5 Wide Distribution with Dome LED Lens)
N*	(T5 Narrow Distribution with Flat LED Lens)

*12w is narrow only, select "N".

3 COLOR TEMPERATURE (CCT)

27K	(2700K)
30K	(3000K)
35K	(3500K)
40K	(4000K)

4 DRIVER HOUSINGS* (Driver Housing only Required with Color Cord and/or Emergency Backup Options)

NA	No selection is required if Color Cord or Emergency Backup are not chosen
Color Cord Driver Housing Options Choose Color Cord Style in Box 5	
CRD-DCC	(Driver Housing for Color Cord only; 7 3/4" x 1 1/2")
SSC-DCC	(Driver Housing for SS Cable/Color Cord only; 7 3/4" x 1 1/2")
Emergency Backup Driver Housing Options	
CRD-DCCEM-BLC	(Emergency Ballast Housing for Black Cord only; 12" x 1 1/2") Choose NA in Box 5
CRD-DCCEM-WHC	(Emergency Ballast Housing for White Cord only; 12" x 1 1/2") Choose NA in Box 5
CRD-DCCEM	(Emergency Ballast Housing for Color Cord only; 12" x 1 1/2") Choose Color Cord Style in Box 5
ST-DCCEM	(Emergency Ballast Housing for Stem only; 12" x 1 1/2") Choose Stem Size in Box 5
SSC-DCCEM-BLC	(Stainless steel cable with 6-foot black cord and 12" canopy) Choose NA in Box 5
SSC-DCCEM-WHC	(Stainless steel cable with 6-foot white cord and 12" canopy) Choose NA in Box 5
SSC-DCCEM	(Emergency Ballast Housing for SS Cable/Color Cord only; 12" x 1 1/2") Choose Color Cord Style in Box 5

*Driver Housing finish will match fixture finish.

5 MOUNTING SOURCES* (Arm and Wall mounts include mounting plate)

Arm Mounts					
E3	E4	E6	E7	E8	E9
E10	E11	E12	E18		
Cable Mounts (See page 5 for color cord style)					
SSC-BLC-5W	(Stainless steel cable with 6-foot black cord and 5 3/8" canopy)				
SSC-WHC-5W	(Stainless steel cable with 6-foot white cord and 5 3/8" canopy)				

5 MOUNTING SOURCES (Continued)*

Cord Mounts (See page 5 for color cord style)	
NA No Selection Required if: CRD-DCCEM-BLC; CRD-DCCEM-WHC; SSC-DCCEM-BLC or SSC-DCCEM-WHC is chosen in Box 4.	
SJT Cord	
BLC-5W (6' Black 5-wire SJT Cord)	WHC-5W (6' White 5-wire SJT Cord)
Solid Fabric Colored Cords Must Choose DCC Housing in Box 4	
BLSF (6' Black)	ORSF (6' Orange)
GYSF (6' Gray)	LGSF (6' Lime Green)
CHSF (6' Chocolate Brown)	KGSF (6' Kelly Green)
WHSF (6' White)	CBSF (6' Cobalt Blue)
CASF (6' Cardinal)	SBSF (6' Sky Blue)
Patterned Fabric Colored Cords Must Choose DCC Housing in Box 4	
BWHPF (6' Black/White Houndstooth)	BIHPF (6' Brown/Ivory Houndstooth)
GYCPF (6' Gray/Citrus Yellow)	MOSPF (6' Magenta/Orange Stripe)
NMTPF (6' Navy Mini Tweed)	
Glossy Fabric Colored Cords Must Choose DCC Housing in Box 4	
GMGF (6' Gun Metal)	SSGF (6' Sterling Silver)
CPGF (6' Copper Penny)	BRGF (6' Bronze)
GOGF (6' Gold)	
Stem Mounts (Includes STC Flat Canopy)	
1/2" (13/16" OD) Rigid Stems	3/4" (1" OD) Rigid Stems
2ST6 2ST12 2ST18	3ST6 3ST12 3ST18
2ST24 2ST36 2ST48	3ST24 3ST36 3ST48
2ST60 2ST72 2ST96	3ST60 3ST72 3ST96

*Arm mount, Wall mount or Stem finish will match fixture finish.

Project: _____

Fixture Type: _____ Quantity: _____

Customer: _____

6 GLASS & GUARD*	
Up to 24w MAX	
100GLCL	(Clear Glass)
100GLFR	(Frosted Glass)
100GLPR	(Prismatic Glass)
100GLCLGUP	(Clear Glass & Small Wire Guard)
100GLFRGUP	(Frosted Glass & Small Wire Guard)
100GLPRGUP	(Prismatic Glass & Small Wire Guard)
100GLCLGUPC	(Clear Glass & Cast Guard)
100GLFRGUPC	(Frosted Glass & Cast Guard)
100GLPRGUPC	(Prismatic Glass & Cast Guard)
100GLGUP	(Small Wire Guard with No Glass)
100GLGUPC	(Cast Guard with No Glass)
*Cast or Wire Guard finish will match fixture finish.	

7 ACCESSORIES**	
CBC	(Cast back plate Spun Alum Cover)**
*EMG-LED06	(6w, LED Emergency Driver, remote placement, Cree module only, Not applicable for 12w LED) MUST CHOOSE DCCM CANOPY IN BOX 4.
*EMG-LED10	(10w, LED Emergency Driver, remote placement, Cree module only, Not applicable for 12w LED) MUST CHOOSE DCCM CANOPY IN BOX 4.
*EMG-LED16	(16w, LED Emergency Driver, remote placement, Cree module only, Not applicable for 12w LED) MUST CHOOSE DCCM CANOPY IN BOX 4.
*EMG-LED20	(20w, LED Emergency Driver, remote placement, Cree module only, Not applicable for 12w LED) MUST CHOOSE DCCM CANOPY IN BOX 4.
SC	(Scroll for Arms)**
SLC	(Sloped Ceiling Mount, 20° Max)**
SQ	(Square Back Plate)**
TBK	(Turn Buckle Kit)**
*For Emergency lumen output data, see Technical section at www.ANPLighting.com.	
**Accessory finish will match fixture finish.	

8 9 FINISHES					
*Marine Grade Finish has an additional charge					
Standard Colors	Standard Grade	Marine Grade*	Premium Colors	Premium Grade	Marine Grade*
Aspen Green	10	10M	High Gloss Black	01	01M
Cantaloupe	11	11M	Arctic Silver	14	14M
Lilac	12	12M	Candy Apple Red	64	64M
Putty	13	13M	Cobalt Blue	65	65M
Raw Unfinished	40	NA	Caramel	66	66M
Black	41	41M	Butterscotch	67	67M
Forest Green	42	42M	Black Silver	68	68M
Bright Red	43	43M	Gunmetal Gray	69	69M
White	44	44M	Mayan Gold	79	NA
Bright Blue	45	45M	Textured Desert Stone	80	80M
Sunny Yellow	46	46M	Extreme Chrome	81	81M
Aqua Green	47	47M	Graystone	82	82M
Galvanized	49	NA	Oil Rubbed Bronze	83	83M
Navy	50	50M	Carbon Graphite	96	96M
Architectural Bronze	51	51M			
Patina Verde	52	52M			
Copper Clay	53	53M			
Silver	56	56M			
Black Verde	61	61M			
Painted Chrome	70	70M			
Painted Copper	71	71M			
Textured Black	72	72M			
Matte Black	73	73M			
Textured Architectural Bronze	76	76M			
Textured White	77	77M			
Textured Silver	78	78M			
Consult Factory for additional paint charges and availability.					

10 VOLTAGE	
UNV (120-277)	

Project: _____
 Fixture Type: _____ Quantity: _____
 Customer: _____

LED MODULE SPECIFICATIONS

LED Wattage	CCT	Typical Luminous Flux	System Wattage	Typical Efficacy
9W	2700K	850	11W	97
	3000K	850	11W	97
	3500K	850	11W	97
	4000K	850	11W	97
10W	2700K	1250	12W	125
	3000K	1250	12W	125
	3500K	1250	12W	125
	4000K	1250	12W	125
12W	2700K	750	12W	65
	3000K	750	12W	65
	3500K	750	12W	65
	4000K	750	12W	65
16W	2700K	2000	19W	125
	3000K	2000	19W	125
	3500K	2000	19W	125
	4000K	2000	19W	125
24W	2700K	3000	29W	125
	3000K	3000	29W	125
	3500K	3000	29W	125
	4000K	3000	29W	125
37W	2700K	4000	43W	108
	3000K	4000	43W	108
	3500K	4000	43W	108
	4000K	4000	43W	108

MODULE SPECIFICATION:

- Efficacy 65-125 lumens per watt
- Life: L70 50,000 hours
- Color temp: 2700K, 3000K, 3500K and 4000K
- CRI: >90

MODULE DRIVER SPECIFICATION:

- Input Voltage: 120-277 Volts; 50/60Hz
- Dimmable down to 1%
- 0-10V, TRIAC and ELV dimming protocols are standard. (12w is 120v and TRIAC dimming only)
- Output Current: Constant Current; 440mA to 940mA (model dependent)
- Driver Efficiency > 80%; Power Factor > 0.9
- Integral Surge Protection in conformance to ANSI C62.41 Category A.

MODULE LISTINGS

- Fully compliant with the RoHS Directive
- Certifications: CE/UL

WARRANTY

See www.ANPlighting.com for complete fixture warranty.

LED warranty information

- 5 year limited warranty*

*Limited Warranty: A typical year is defined as 4380 hours of operation

Project: _____
 Fixture Type: _____ Quantity: _____
 Customer: _____



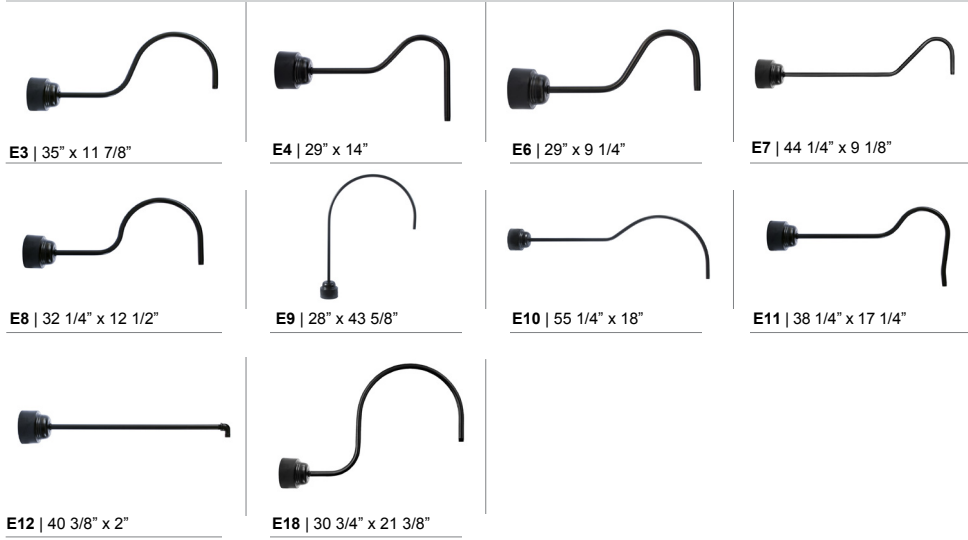

ARM MOUNTS | Dimensions are Projection x Height | CB included with all arms | Arm will match fixture finish



ACCESSORIES







Driver Housings

	CRD-DCC (7 3/4" x 1 1/2") Cord Only
	SSC-DCC (7 3/4" x 1 1/2") Cable/Cord Only
	ST-DCC (12" x 1 1/2") Stem Only
	CRD-DCC (12" x 1 1/2") Cord Only
	SSC-DCC (12" x 1 1/2") Cable/Cord Only

**GLASS & GUARDS
UP TO 24W MAX**

Glass Legend: CL = Clear FR = Frosted PR = Prismatic
 100 = Small 200 = Large

Glass Only (6 1/2" H X 4 1/8" W)	
	100GLCL 100GLFR 100GLPR
Glass with Cast Guard (7 1/2" H X 4 1/8" W)	
	100GLCLGUP 100GLFRGUP 100GLPRGUP
Glass with Wire Guard (7 1/2" H X 4 1/8" W)	
	100GLCLGUP 100GLFRGUP 100GLPRGUP
Guards Only (7 1/2" H X 4 1/8" W)	
	100GLGUP (Cast Guard)
	100GLGUP (Wire Guard)

Project: _____

Fixture Type: _____ Quantity: _____

Customer: _____

All fabric Color Cords are three conductor, 1/4" diameter

Solid Fabric Colored Cords



BLSF | Black



GYSF | Gray

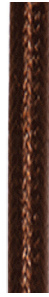

CHSF | Chocolate Brown



WHSF | White

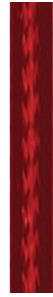

CASF | Cardinal



ORSF | Orange



LGSF | Lime Green



KGSF | Kelly Green



CBSF | Cobalt Blue



SBSF | Sky Blue

Patterned Fabric Colored Cords



BWHPF | Black/White Houndstooth



BIHPF | Brown/Ivory Houndstooth



GYCPF | Gray/Citrus Yellow



MOSPF | Magenta/Orange Stripe



NMTPF | Navy Mini Tweed

Glossy Fabric Colored Cords



GMGF | Gun Metal



SSGF | Sterling Silver



CPGF | Copper Penny



BRGF | Bronze



GOGF | Gold